

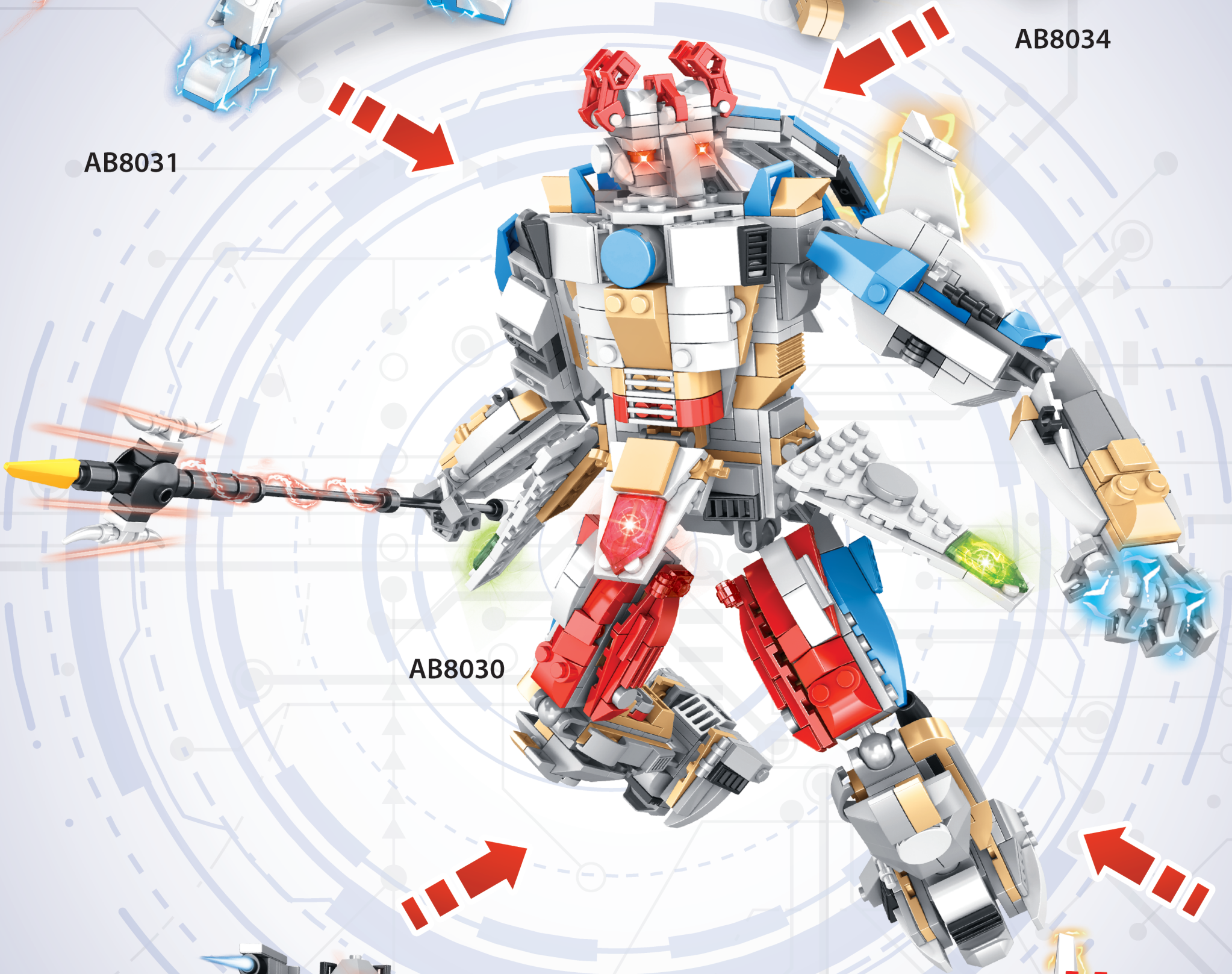

AB8031



AB8034



AB8030



AB8032

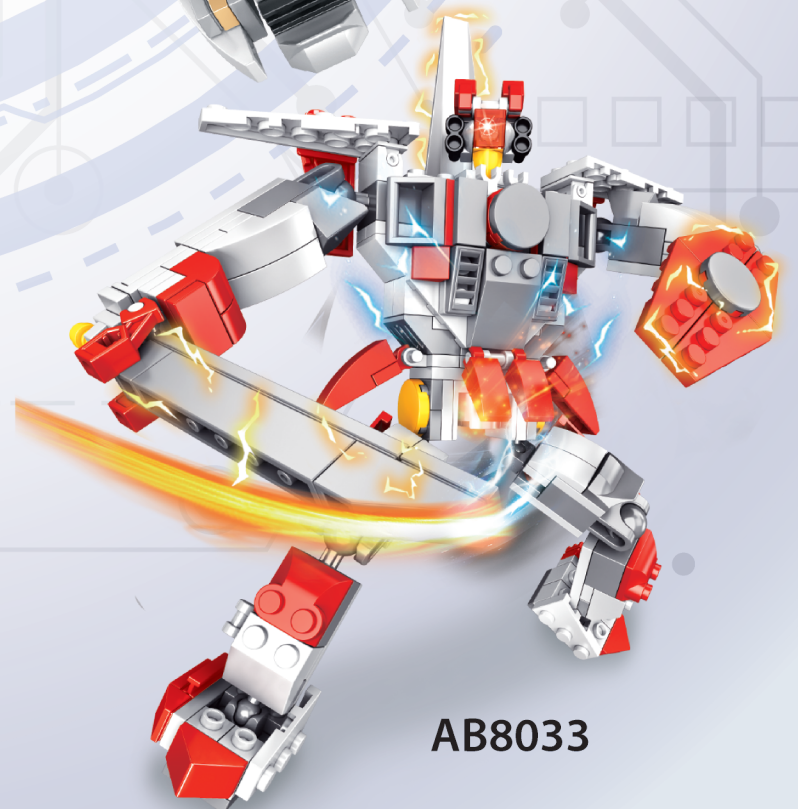

AB8033

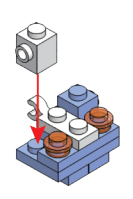
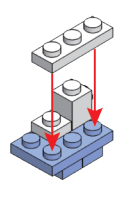
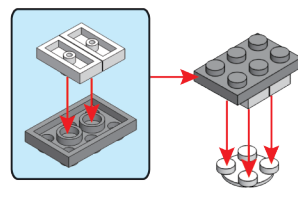
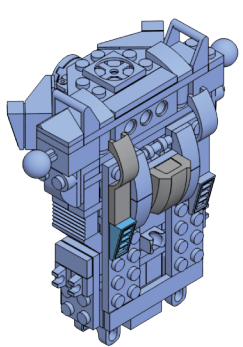
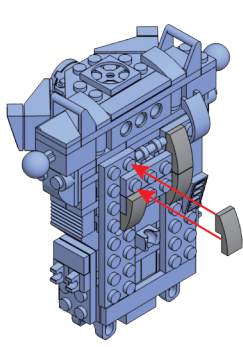
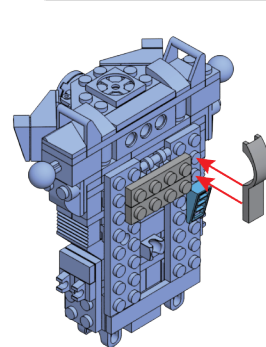
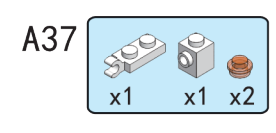
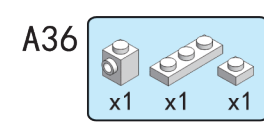
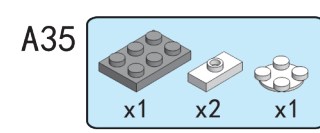
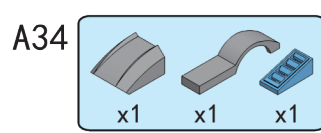
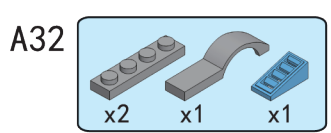
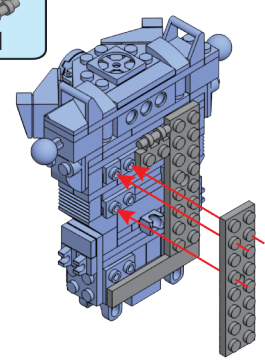
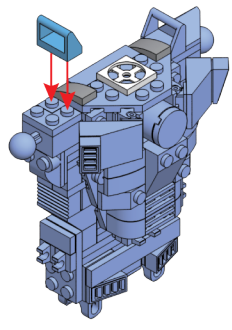
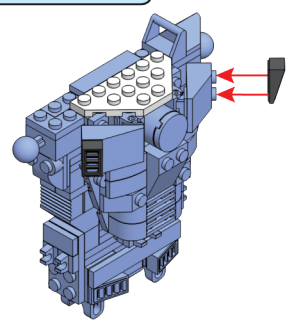
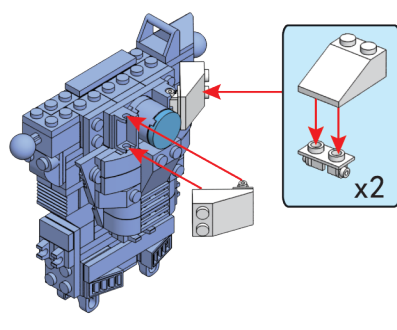
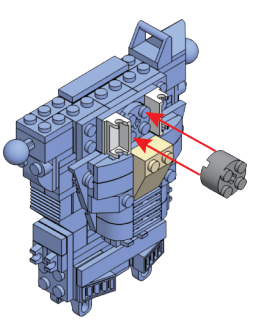
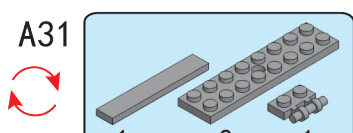
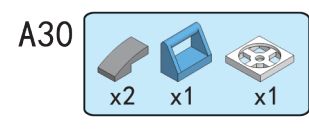
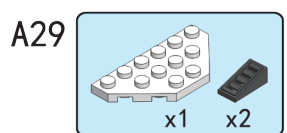
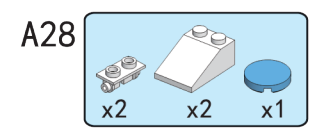
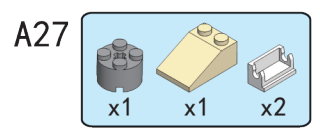
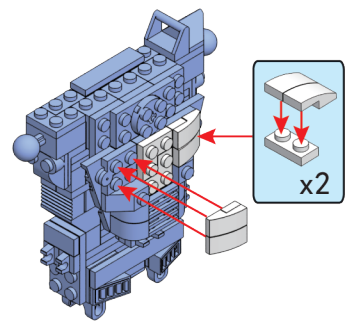
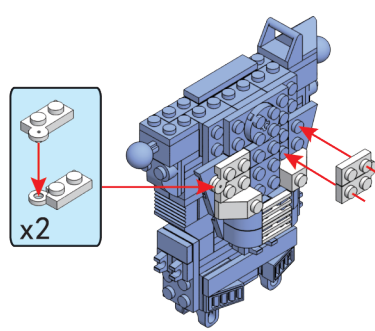
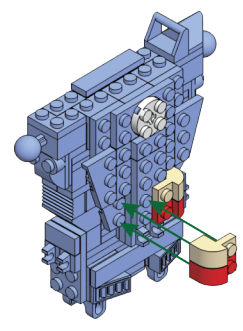
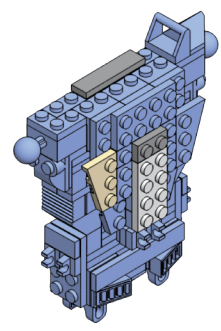
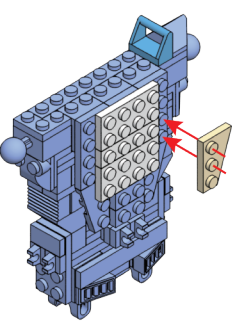
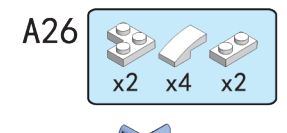
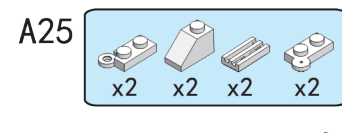
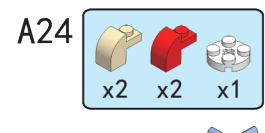
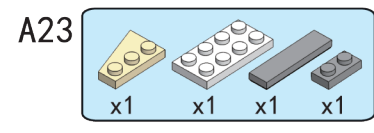
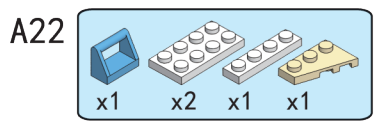
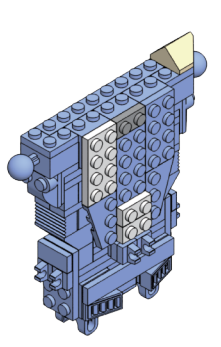
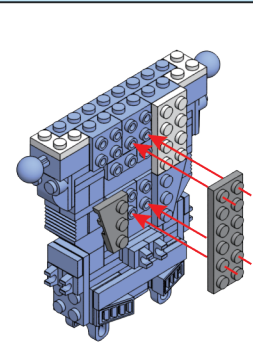
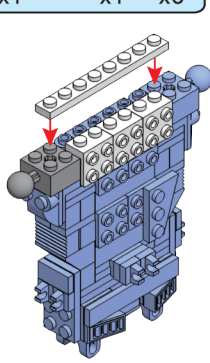
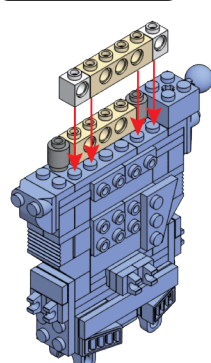
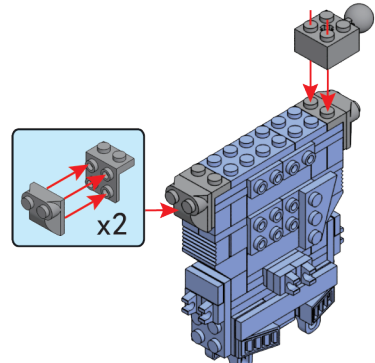
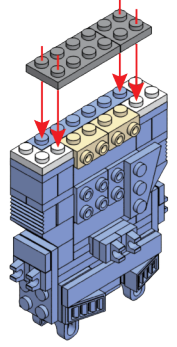
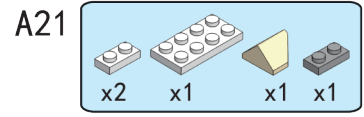
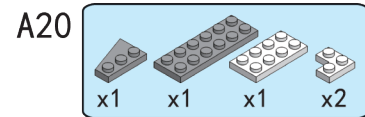
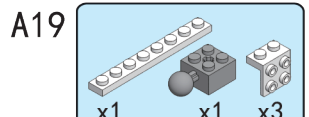
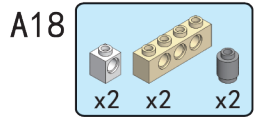
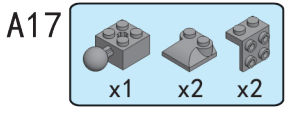
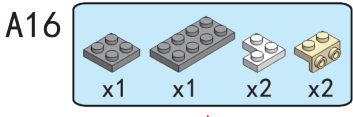
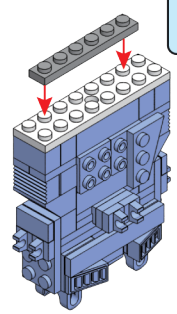
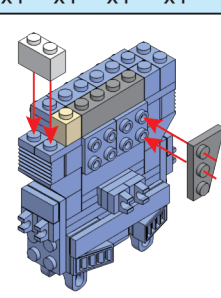
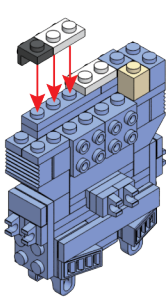
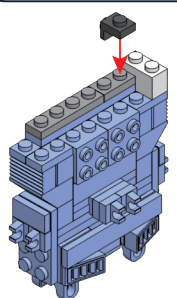
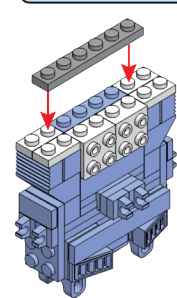
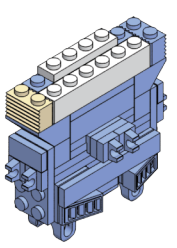
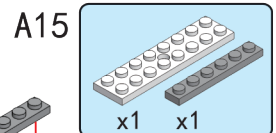
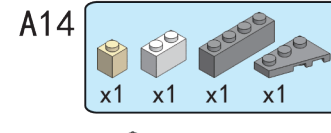
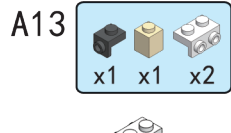
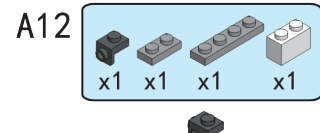
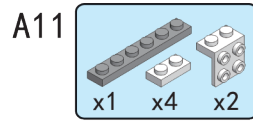
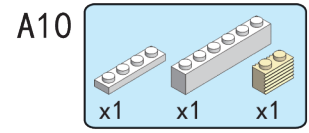
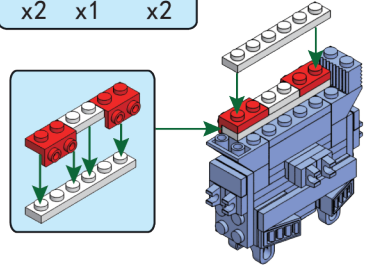
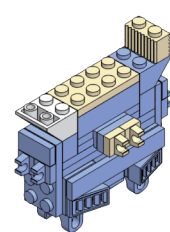
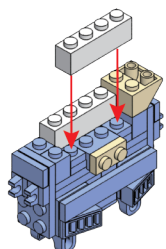
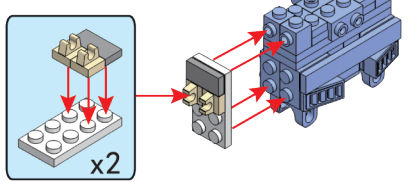
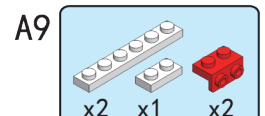
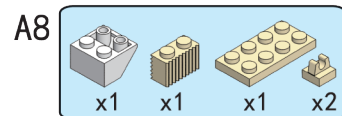
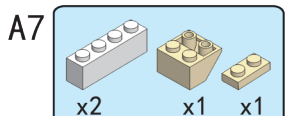
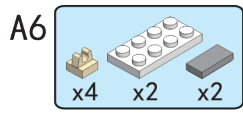
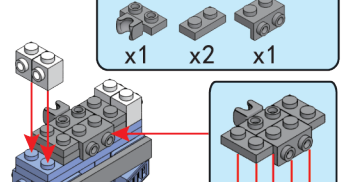
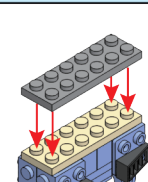
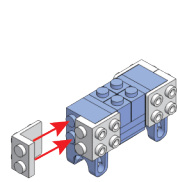
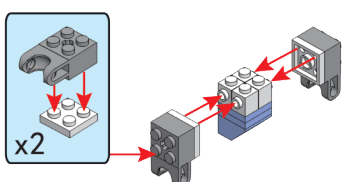
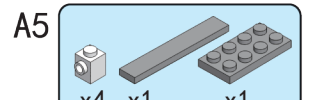
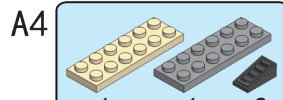
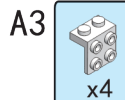
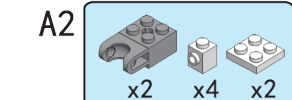
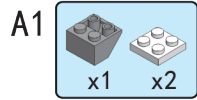
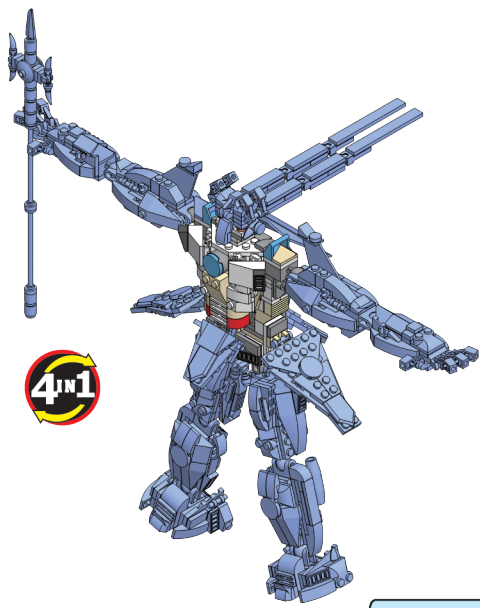



B1
x2 x1 x2

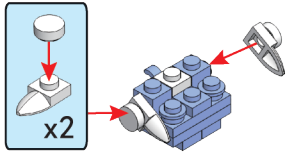

B2
x1 x2 x1 x1

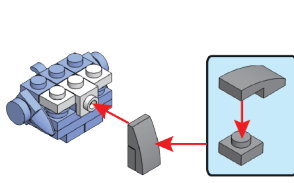

B3
x2 x1 x1 x2

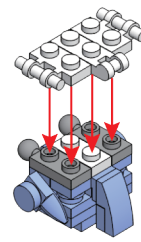

B4
x2

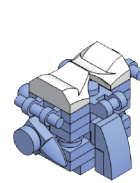

B5
x5

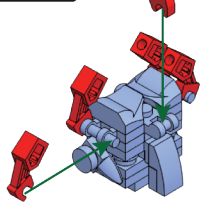

B6
x1

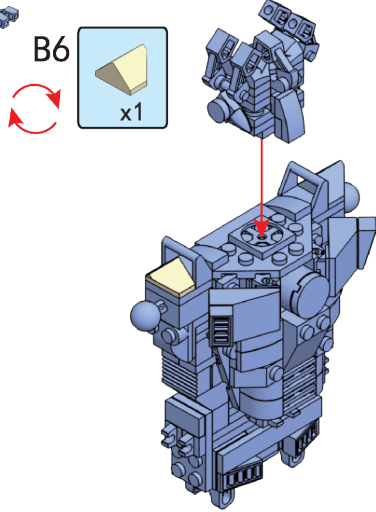

B7
x8 x2

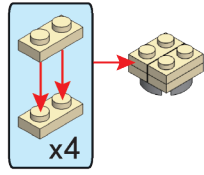

B8
x2 x2 x8

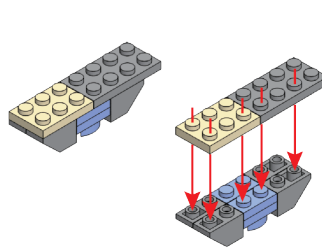

B9
x2 x2 x4

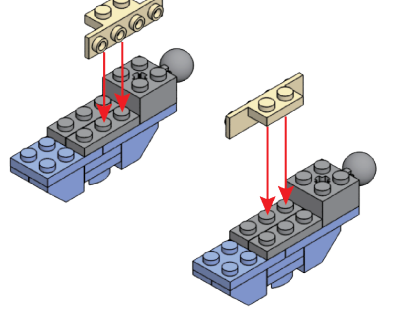

B10
x2 x2 x2

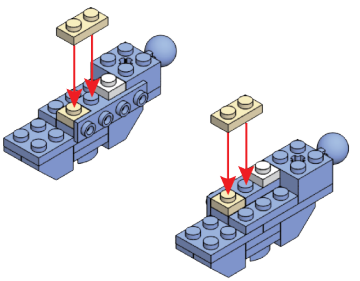

B11
x2 x2 x6

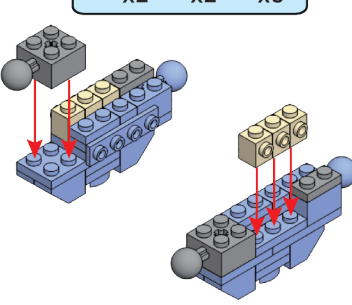

B12
x2 x2 x2

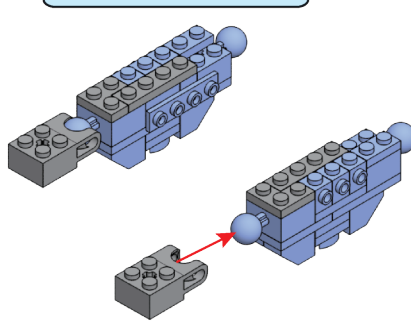

B13
x2 x2 x2

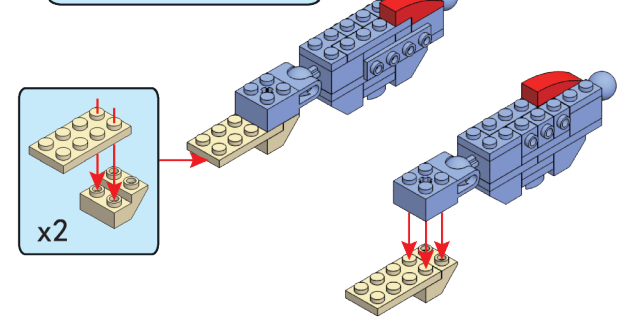

B14
x2 x1 x2 x2

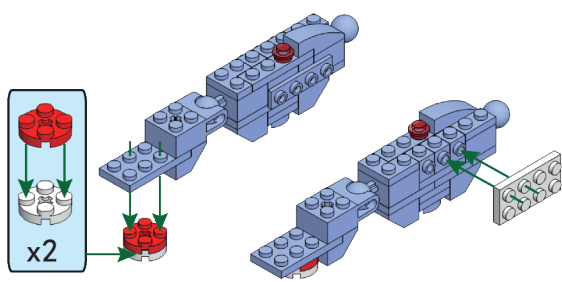

B15
x1 x1 x2 x1

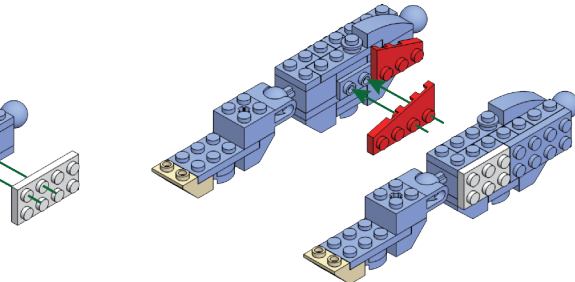

B16
x1 x4 x1 x4

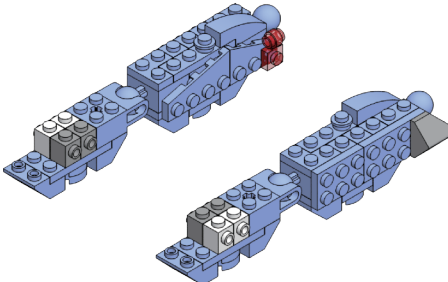

B17
x2 x1 x1 x1

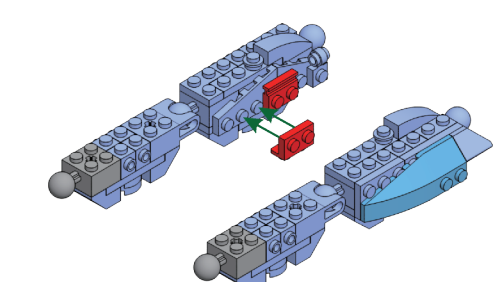

B18
x1 x1 x1 x1

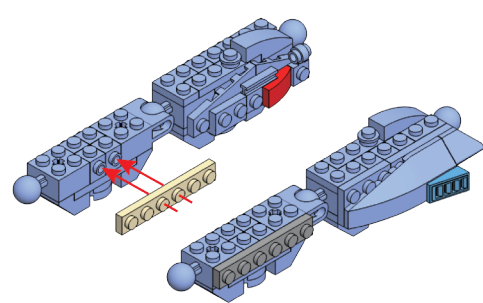

B19
x1 x1 x1 x1

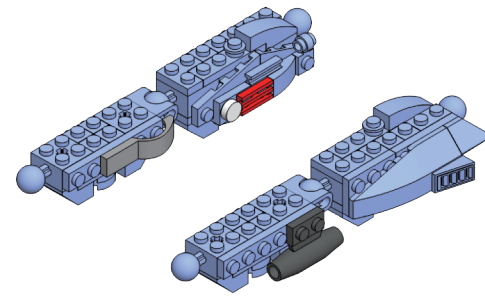

B20
x4 x2 x1 x1

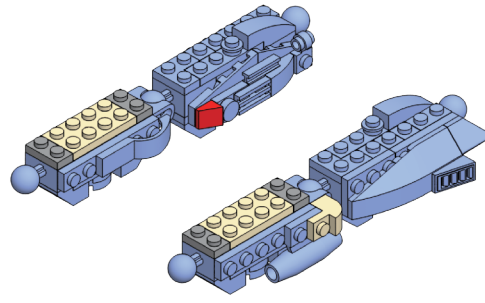

B21
x2 x2 x1

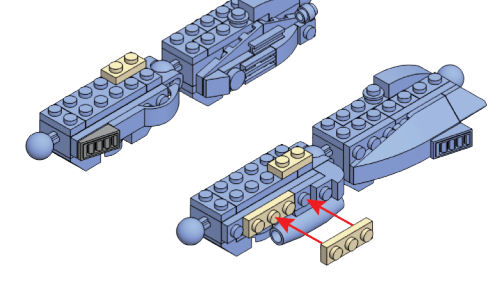

B22
x1 x1

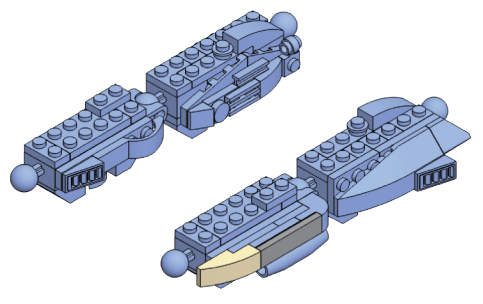

B23
x1 x1 x1 x1

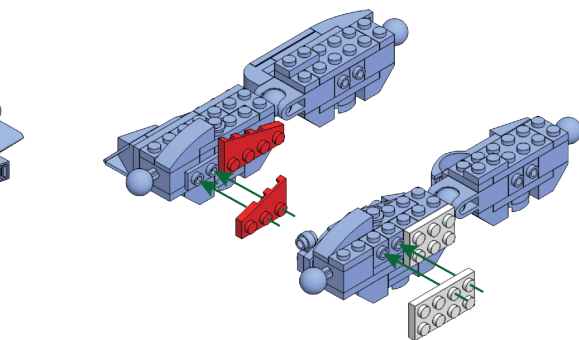

B24
x1 x1 x1 x1

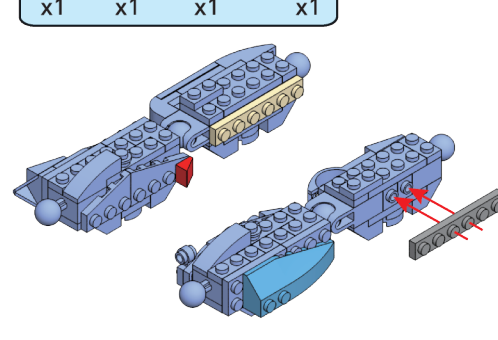

B25
x1 x1 x1 x1

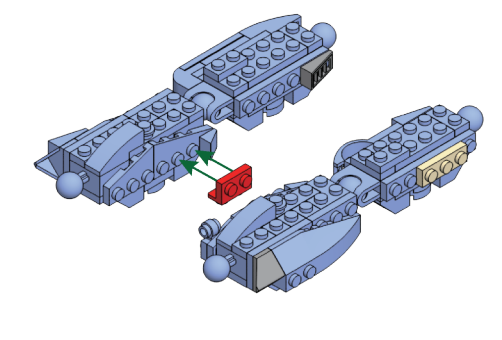

B26
x1 x1 x1 x1

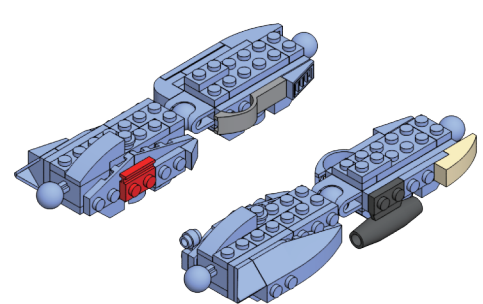

B27
x1 x1 x1 x1 x1

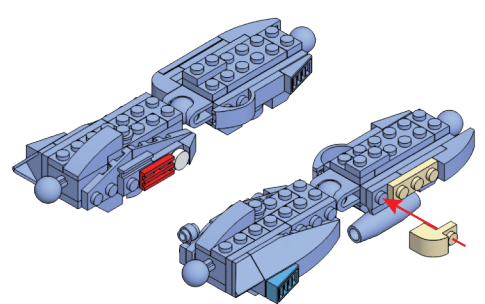

B28
x2 x2 x2 x1

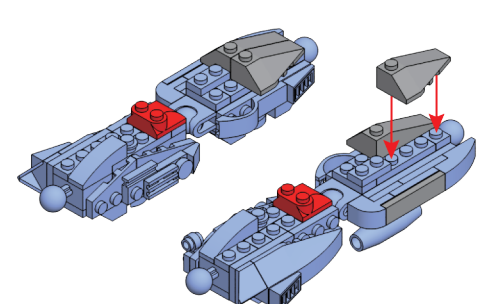

B29
x2 x2 x2 x1

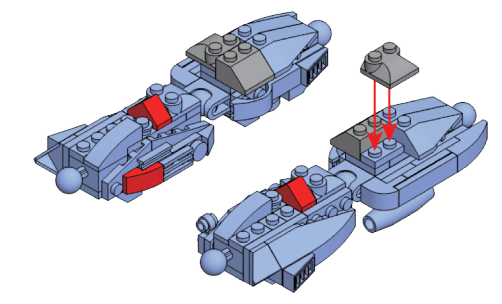

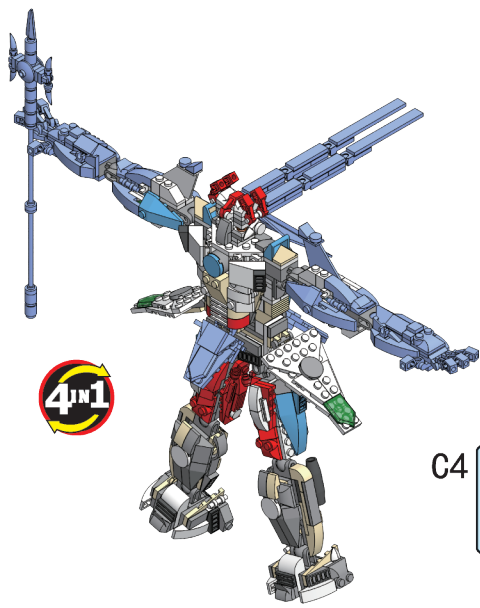

4-in-1

